

LA30RPDC

Technical Product Data

Features

- Covers GPS L1, L2, L5, GLONASS and Galileo frequency bands
- Advanced PHEMT technology
- High gain
- Very Low Noise Figure
- Excellent 1dB compression, 3rd order intercept

Description

The LA30RPDC is a one input, one output device with a nominal 30dB gain block. The frequency response covers Galileo, GLONASS and the L1, L2, L5 GPS bands with excellent flatness. In the default configuration, the RF output (J1) passes DC from the connected GPS receiver through the amplifier to the active antenna, allowing the GPS receiver to power both the antenna and the LA30RPDC amplifier.

Electrical Specifications, $T_A = 25^\circ\text{C}$

Parameter	Conditions	Min	Typ	Max	Units
Freq. Range	Antenna - J1	1.176		1.575	GHz
In/Out Impedance	Ant, J1		50		Ω
Gain	Ant – J1	30	31	33	dB
Input VSWR	J1 - 50 Ω			1.8:1	
Output VSWR	Ant – 50 Ω			1.8:1	
Noise Figure	Ant – J1		1.5		dB
Gain Flatness	L5 – L1 , Ant – J1		1.8		dB
Reverse Isolation	J1 – Ant	50			dB
1dB Compression	Ant – J1	13			dBm
3 rd Order Intercept	Ant – J1, Referred to Output	22			dBm
DC Input Voltage	DC Input on J1	2.8		15	Vdc
DC Current ⁽²⁾	Amplifier current draw, All ports 50 Ω		48		mA

Available Options

Network Power Supply		
Source Voltage Options	VOLTAGE INPUT	STYLE
	110VAC	Transformer (Wall Mount)
	220VAC	Transformer (Wall Mount)
	240VAC (United Kingdom)	Transformer (Wall Mount)
	Customer Supplied DC 8 – 32 VDC	Military Style Connector
Output Voltage Options⁽¹⁾	2.8 to 15 VDC	500mA Max. Current
Pass/Block DC Options		
Pass DC ⁽¹⁾	All Ports Pass DC	
DC Blocked ⁽¹⁾	Ant is DC blocked, Pass DC J1	
RF Connector Options	CONNECTOR STYLE	COMMENTS
	Type N	No Charge
	Type SMA	No Charge
	Type TNC	No Charge
	Type BNC	No Charge

(1) With Network Option, any RF port (input or output) can be DC blocked or can pass the network DC voltage.

Part Number

N LA30 RPDC - N / 5 / 110

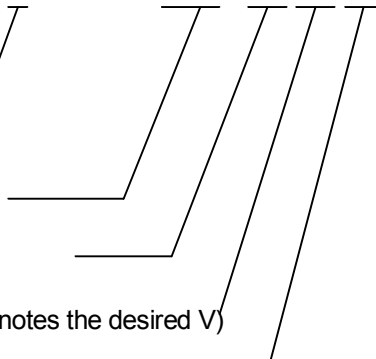

Network Option:
N = Network Option; **Blank** = No Network

DC Options:
DCB = Ant. DC Blocked; **PDC** = Pass DC

Connector Options:
N = N type; **S** = SMA; **T** = TNC; **B** = BNC

DC Output Voltage:
3.3, 5, 7.5, 9, 12, 15, CXX (Custom: "XX" denotes the desired V)

Source Voltage:
110 - Transformer, **220** - Transformer, **240** - Transformer, **MC** - Military Conn. (User supplies DC Voltage)

Mechanical

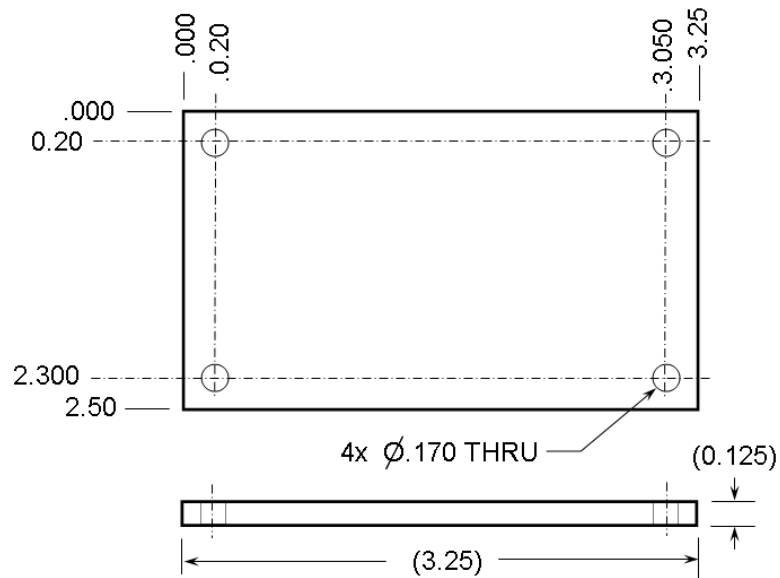

Notes:

1. Material: 6061-T6 Aluminum, 0.125 Thick
2. Finish: Electroless Nickel Plated, 0.0001 – 0.0003 Max. Thickness

Mounting Base Plate